

Istruzioni di montaggio

Telaio veicolo: Euro Chassi 230/244FL (Fiat Ducato, Citroen, Peugeot)

Designazione SMV: RV2100N Valore-D 12.5KN

No.-Art. 1022910000207

SMV-Metall GmbH
Bruchheide 8
D - 49163 Bohmte

Telefon: +49 (0) 5471 9583 - 0
Telefax: +49 (0) 5471 9583 - 20

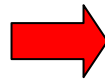

Preparazione montaggio



Area	Nr.01	Nr.02	Nr.03
Longhezza longerone <750mm			
Longhezza longerone >=750-<1200mm			
Longhezza longerone >=1200mm			

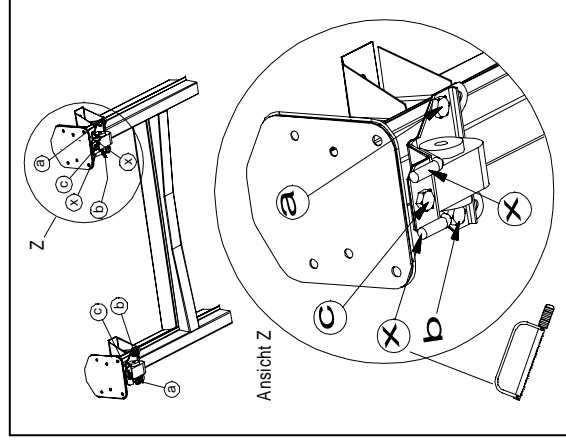

Pos 80
Montaggio
secondo T0009

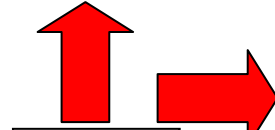
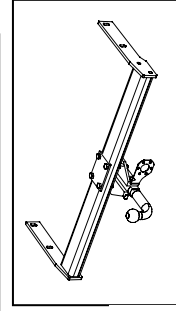
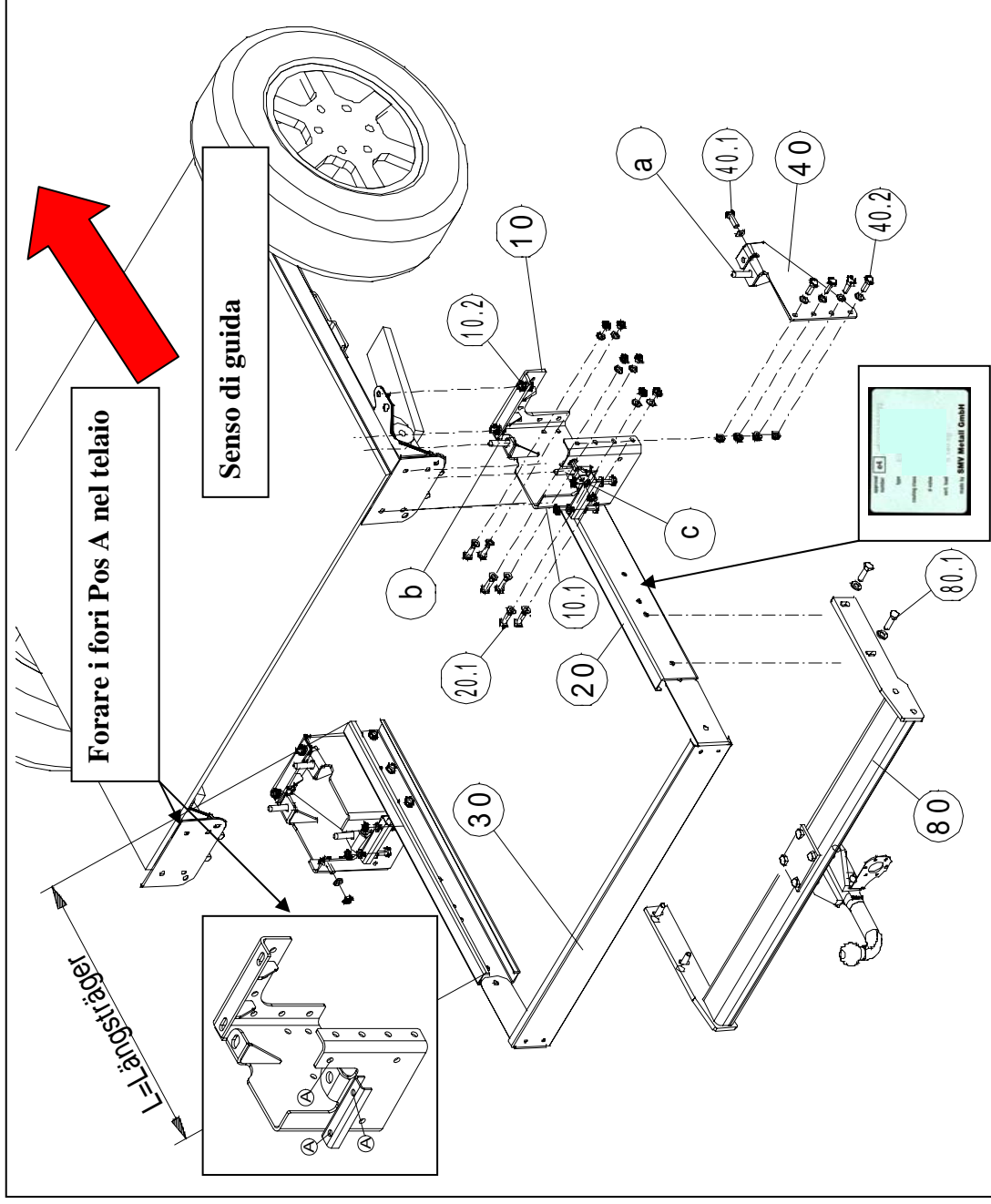
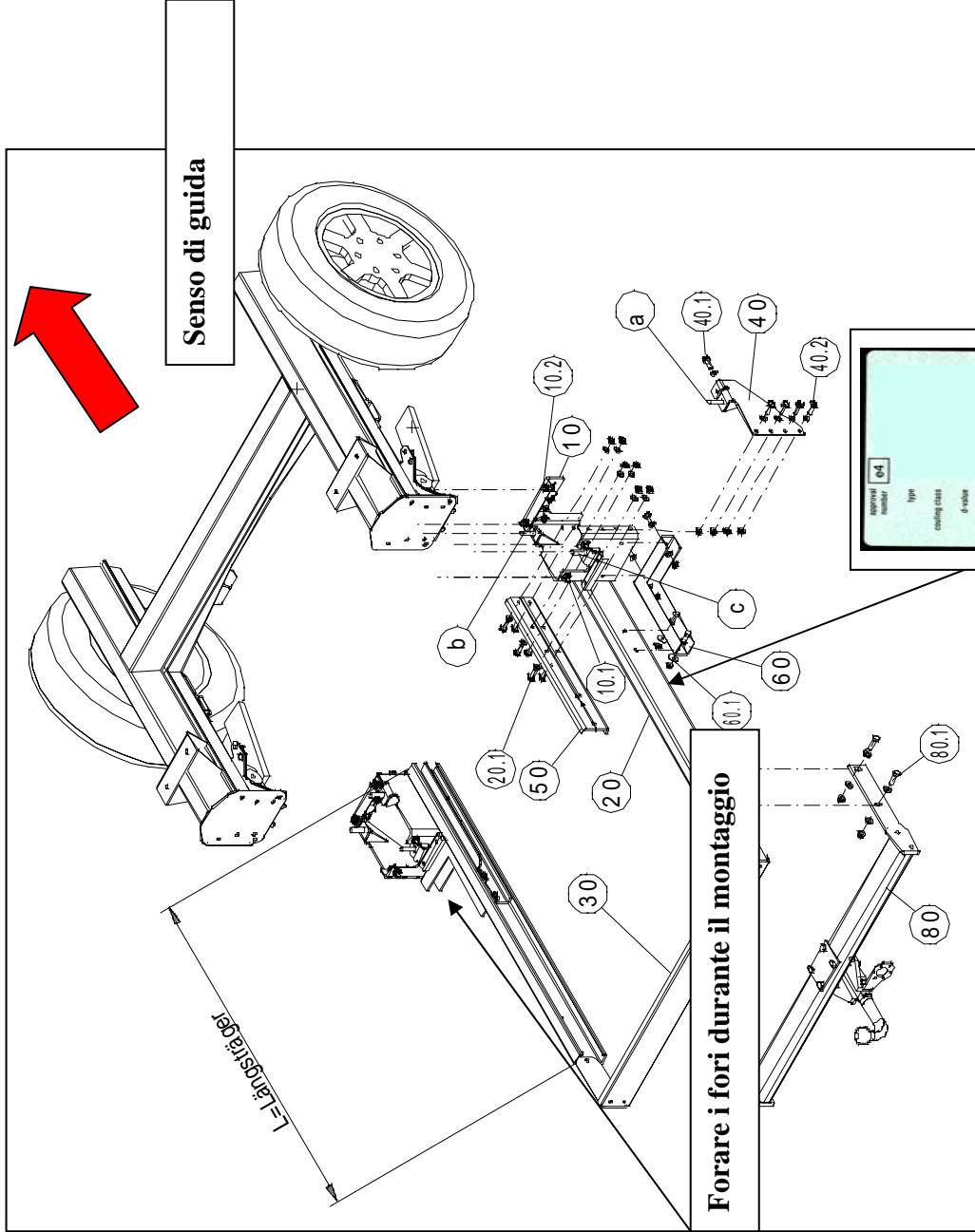

Image No. 01 Longerone (Pos 20) <750mm



Istruzioni di montaggio	No.-Art.	1022910000207
Telaio veicolo:	Euro Chassi 230/244FL (Fiat Ducato,Citroen,Peugeot)	
Designazione SMV:	RV2100N Valore-D 12.5KN	

Image Nr. 02 Longerone (Pos 20) >=750mm<1200mm



SMV-Metall GmbH
Bruchheide 8
D - 49163 Bohmte
Telefon: +49 (0) 5471 9583 - 0
Telefax: +49 (0) 5471 9583 - 20

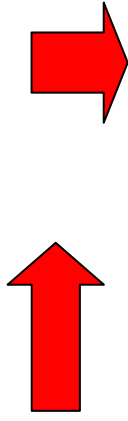

**Image No. 03 Longerone (Pos 20) >=1200mm
Premessa Image 02**

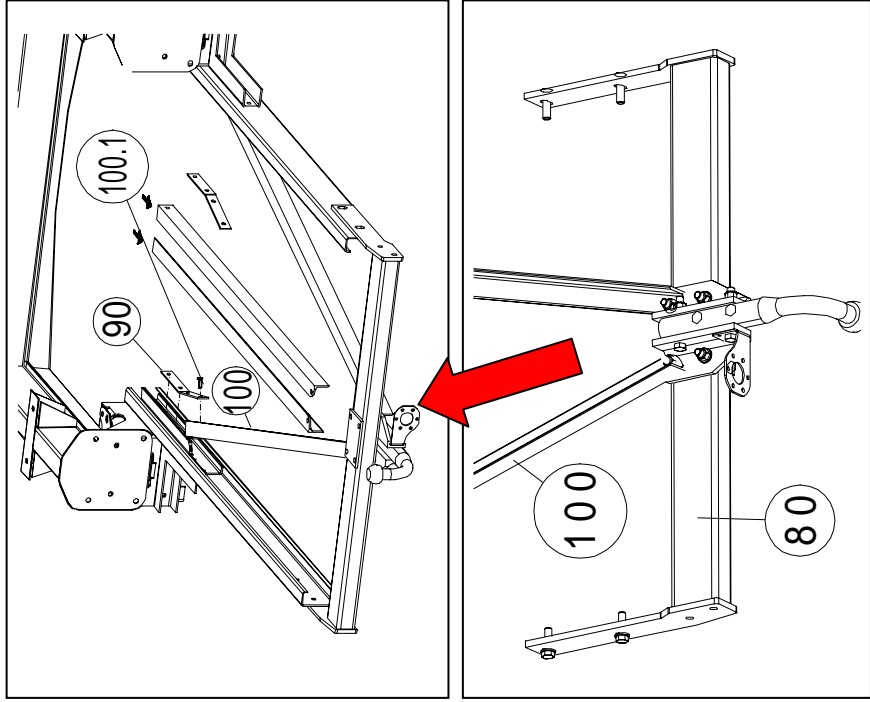

Istruzioni di montaggio		No.-Art.	1022910000207
Telaio veicolo:		Euro Chassi 230/244FL (Fiat Ducato,Citroen,Peugeot)	
Designazione SMV:		RV2100N Valore-D 12.5KN	

SMV-Metall GmbH
Bruchheide 8
D - 49163 Bohmte

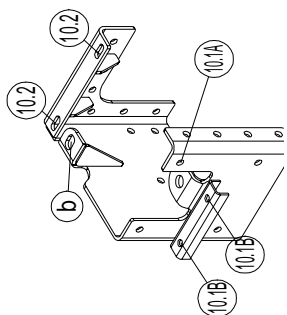
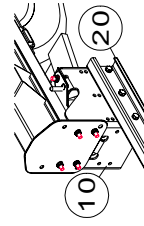
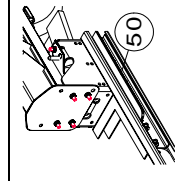
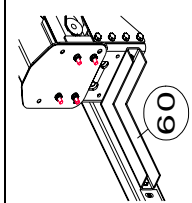

Telefon: +49 (0) 5471 9583 - 0
Telefax: +49 (0) 5471 9583 - 20

Step	Validità Imag. No.	Pos	Designazione	Visione	Materiale
01	01/02/03	10	Adattatore Telaio		10.1A 2x Viti DIN 933-M10x30 8.8 galzn 4x Rondelle DIN 125-A10.5 galzn 2x Dadi DIN 985-M10 8.8galzn Copiare foratura A al Chassis 4x Viti DIN 912-M10x40 8.8 galzn 8x Rondelle DIN 125-A10.5 galzn 4x Dadi DIN 985-M10 8.8 galzn 4x Viti DIN 933-M10x40 8.8 galzn 8x Rondelle DIN 125-A10.5 galzn 4x Dadi DIN 985-M10 8.8galzn 4x viti originali b,c avvertenza A
02	01	10+20	Longherone		20.1 12x Viti DIN 933-M10x30-10.9 galzn 24x Rondelle DIN 125-A10.5 galzn 12x Dadi DIN 985-M10-10 galzn
02	02/03	10+20+50	Profilo di rinforzo		
03	02/03	10+20+60	Rinforzo a L,		60.1 8x Viti DIN 933-M10x30 8.8 galzn 16x Rondelle DIN 125-A10.5 galzn 8x Dadi DIN 985-M10 galzn

Momento di serraggio secondo T0002

Istruzioni di montaggio		No.-Art.	1022910000207
Telaio veicolo:		Euro Chassi 230/244FL (Fiat Ducato,Citroen,Peugeot)	
Designazione SMV:		RV2100N Valore-D 12.5KN	

SMV-Metall GmbH
Bruchheide 8
D - 49163 Bohmte

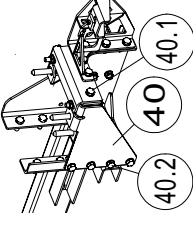
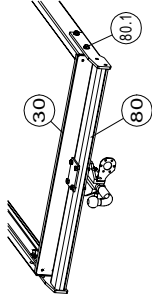
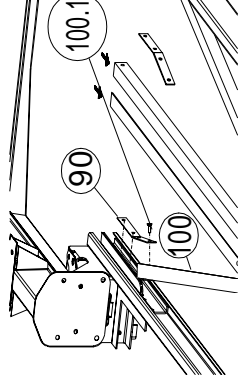

Telefon: +49 (0) 5471 9583 - 0
Telefax: +49 (0) 5471 9583 - 20

04	01/02/03	10+40	Gamba di rinforzo,		40.1 40.2	2x Viti DIN 933-M10x30 8.8 galzn 4x Rondelle DIN 125-A10.5 galzn 2x Dadi DIN 985-M10 galzn 8x Viti DIN 933-M10x30 8.8 galzn 16x Rondelle DIN 125-A10.5 galzn 8x Dadi DIN 985-M10 galzn 2x viti originali a avvertenza B
05	01/02/03	20+30(optional)+80	Gancio Traino,		80.1	4x Viti DIN 933-M12x40 8.8galzn 8x Rondelle DIN 125-A13alzn 4x Dadi DIN 985-M10 galzn
06	03	10+20+50+90	Piatto di rinforzo,		20.1	Vedere 20.1
07	03	80+90+100	Tiranti		100.1 100	2x Viti DIN 933-M10x30 10.9galzn 4x Rondelle DIN 125-A10.5 galzn 2x Dadi DIN 985-M10-10 galzn +Fissaggio a Pos 80 Attenzione: la lunghezza dei tiranti deve essere adattata. Significa accorciare e forrare.

Momento di serraggio secondo T0002

Attenzioni!
Prestare attenzione alla protezione di corrosione dopo le forature!
Pulire la superficie di contatto fra l'adattatore del telaio e il telaio della vettura in prossimità dei punti di avvistamento eliminando la cera o le eventuali sostanze di protezione del sottoscocca.

Hinweis!
Coppia di serraggio secondo la tabella T0002.
Tutte le viti di fissaggio devono essere nuovamente serrate dopo un utilizzo di circa 1000km!
Per evitare che l'assicurazione di responsabilità civile della vettura decada, in caso di ulteriori montaggi di sistema, servirsi esclusivamente di elementi di montaggio della ditta SMV-Metall! Tutti gli elementi di montaggio possono essere riutilizzati senza problemi nel caso in cui si cambiasse vettura. Soltanto il telaio di base e gli elementi di fissaggio devono essere adatti al modello specifico!
Importante!
Vi preghiamo di non gettare via le presenti istruzioni di montaggio, poiché devono essere conservate con il certificato di singoli elementi unitamente ai documenti del veicolo.

Istruzioni di montaggio	No.-Art.	1022910000207
Telaio veicolo:	Euro Chassi 230/244FL (Fiat Ducato, Citroen, Peugeot)	
Designazione SMV:	RV2100N Valore-D 12.5KN	

SMV-Metall GmbH
 Bruchheide 8
 D - 49163 Bohmte

Telefon: +49 (0) 5471 9583 - 0
 Telefax: +49 (0) 5471 9583 - 20

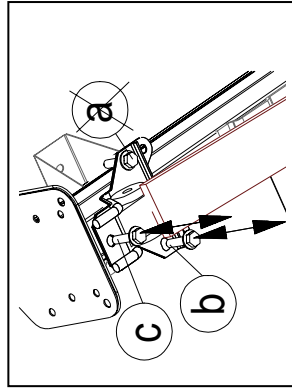

Avvertenza A

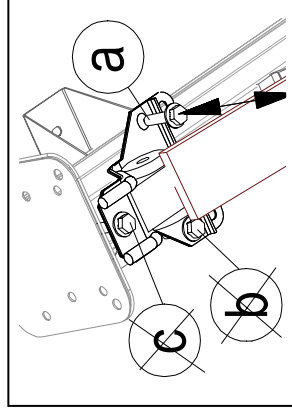

Avvertenza B



Documentazione SMV-Metall

Istruzione di montaggio Gancio Traino valore-D 12.5kN RV2100

Montaggio Gancio Traino D-Wert 12.5kN

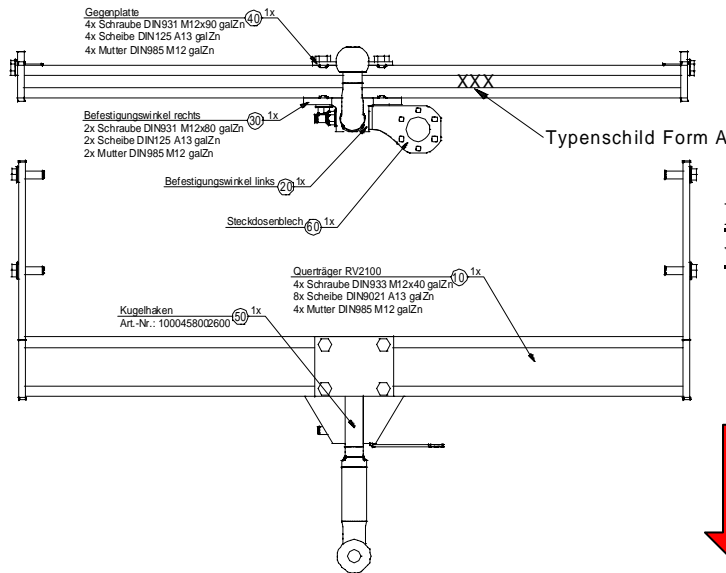

Istruzione di montaggio Gancio Traino valore-D 12.5kN

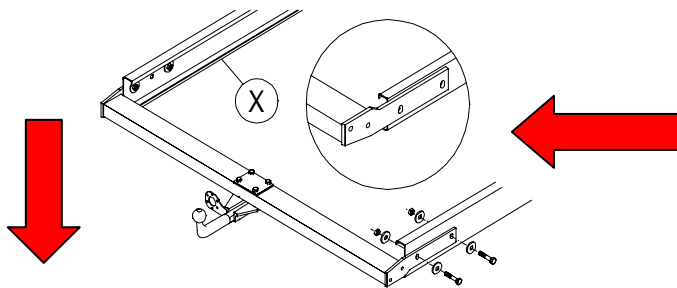
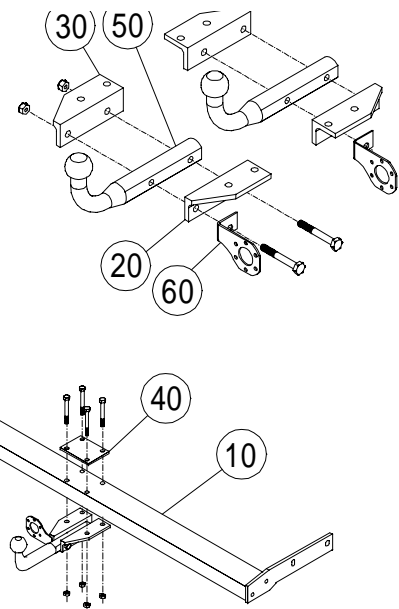

Versioni di montaggio ammissibili per Gancio Traino valore-Dt 12.5kN

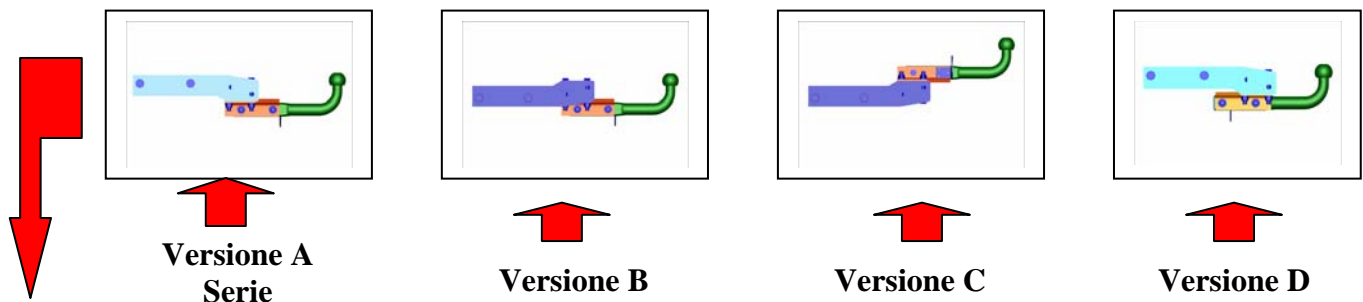

Versione	Misure veicolo vuoto min ZL mm	Misure veicolo carico mass ZV mm	Misura versione ZK mm
A/D	407mm	337mm	13mm
B	365mm	295mm	55mm
C	255mm	165mm	165mm

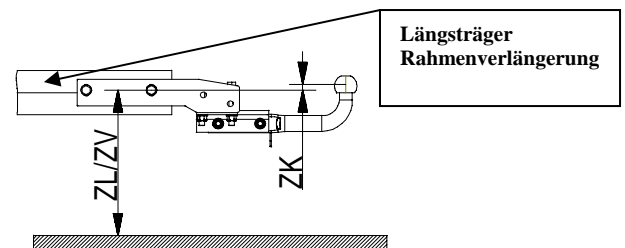



Documentazione SMV-Metall

Istruzione di montaggio Gancio Traino valore-D 12.5KN RV2100



Plaque Form A

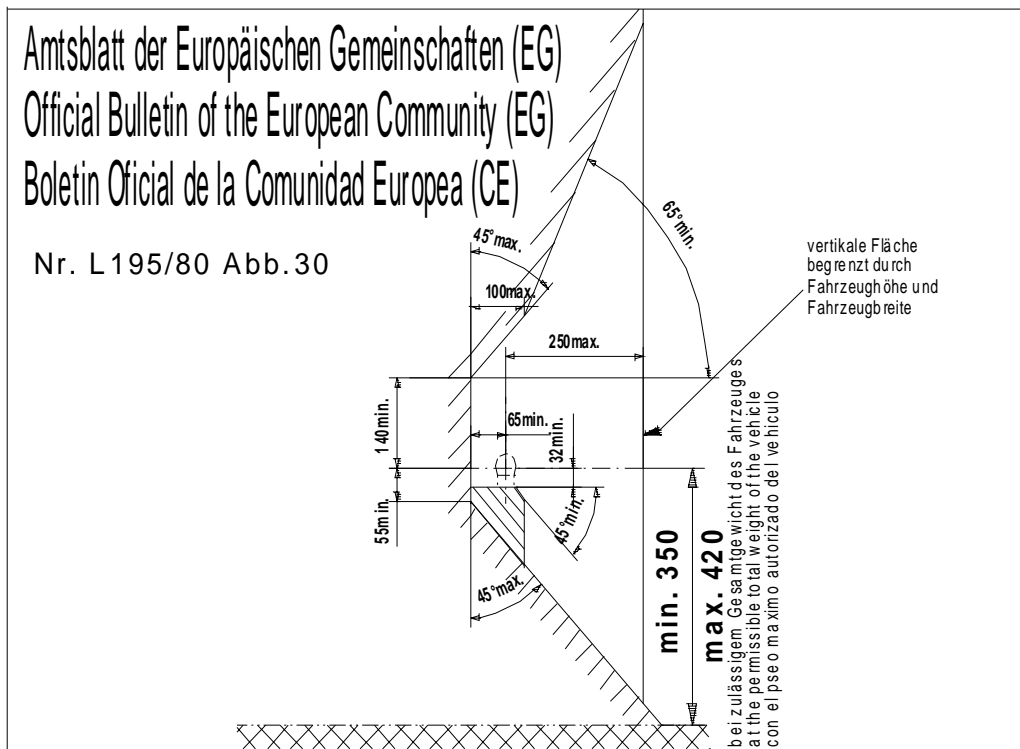



Documentazione SMV

Vite- Dimensioni	Reibwert y ges.	Momento di serraggio MA max (Ncm)						
		4.6	4.8	5.6	5.8	8.8	10.9	12.9
M 3	0,125	44	56	72	128	180	215	
M 3,5	0,125	68	86	110	196	275	330	
M 4	0,125	102	128	166	290	410	495	
M 5	0,125	200	250	320	575	810	970	
Momento di serraggio MA max (Nm)								
M 6	0,125	3,4	4,3	5,6	9,9	14	16,5	
M 7	0,125	5,7	7,1	9,3	16,5	23	27	
M 8	0,128	8,3	10,5	13,6	24	34	40	
M 10	0,125	16,6	21	27	48	67	81	
M 12	0,125	29	36	47	83	117	140	
M 14	0,125	46	58	74	132	185	220	
M 16	0,125	70	88	115	200	285	340	
M 18	0,125	95	121	155	275	390	470	
M 20	0,125	135	171	219	390	550	660	